

BREEZE™

The Senior Class Lifestyler

USER MANUAL



AFIM ELECTRIC VEHICLES

WARNING

Read the User's Manual carefully before operating the **Breeze**. If you do not fully understand any part of this Manual, please contact your dealer or any of our Service Center. Read this manual step by step, as injury or damage may occur from misuse!

WARNING

Electromagnetic Interference ("EMI") can cause powered vehicles to behave erratically, which could be dangerous to the user. For your safety and protection, it is **IMPERATIVE** that you take time to read Chapter 6 ("EMI WARNING") before operating the **Breeze**.

Serial Number and Manufacturer's data are fixed to the top of the Batteries Cover near the Manual release Lever (subject to change as per local ordinances).

CE CERTIFICATION

The Afikim Electric Vehicles Ref. Registration Number with the Competent Authority (UK) is: CA 000292.
Our Authorized Representative with the Competent Authorities is:

MEDES LTD.POB 231
Stanmore, Middlesex, HA7 4YA, England
TEL/FAX: 0044-181-954-9964

Date: April 2005
Edition: 01
Revision: 02
Products: **Breeze 4 Wheels and 3 Wheels**

I:\BREEZE 4W\Word files\breeze 3W&4W manuals\Breeze-User-Manual-3W&4W-English-rev1.DOC

CONTENTS

CHAPTER 1 - OVERVIEW OF THE <i>Breeze</i> –Main Features:	4
1.1 SAFETY INSTRUCTIONS	5
WARNING !!!	6
WARRANTY	7
1.2 GENERAL DESCRIPTION OF THE <i>Breeze</i>	8
1.3 TECHNICAL SPECIFICATIONS	11
CHAPTER 2 – ADJUST. & OPERATING INSTRUCTIONS	13
CHAPTER 3 - MAINTENANCE	22
CHAPTER 4 - CHARGING	24
CHAPTER 5 - TROUBLESHOOTING AND FAULT REPAIR	25
CHAPTER 6 - EMI WARNING	29

CHAPTER 1 - OVERVIEW OF THE Breeze –Main Features:

Congratulations on choosing the **Breeze** as your electrically powered Scooter.

The **Breeze** is a scooter for Elderly and Disabled persons, Fun and Sport.

Scooter classification: Class C with according to EN12184 .

The **Breeze** is designed to a Maximum occupant mass of 160 Kg (352lbs).

The **Breeze** is an outdoor scooter designed to work at normal environment conditions from very cold areas of (-30°C, -22°F) and up to very hot areas up to (+45°C, +113°F).

The **Breeze** will operate in light splashing rain, But it is not recommended to use the **Breeze** *at heavy rain conditions for long period.*

The **Breeze** is easy to operate. The relatively large wheels enable driving on unpaved roads, over rough terrain and to overcome obstacles as high as 5" (12 cm).

The recommended pressure to inflate the tires is 35psi .The **Breeze** can climb slopes up to 21% (11.85°).

The braking system stops the **Breeze** smoothly and a short distance after the Operating Lever is released.

The **Breeze** is equipped with both Front and Rear Shock Absorbers to give the user the most comfort and soft driving, even when using the vehicle at terrain roads.

A standard hand brake is also provided for backup.

The Seat is spacious, comfortable and can be rotated for easy access (standard Seats) and adjusted forward/reverse up/down for most fitness to the user.

All controls are conveniently located on the tiller and handlebar and are simple to operate.

Under normal conditions the **Breeze** can travel approximately 40 km (26.7 miles) before the batteries require recharge.

After reading through all this manual, before start using the **Breeze**, do a visual check through the all parts of the vehicle, to make sure that no external damage has been occur to the vehicle while transportation. In any case you are not sure call your dealer and ask for an explanation.

The **Breeze** is developed to use dry or gel batteries only.

Please see Figure No. 1 for detailed specifications.

1.1 SAFETY INSTRUCTIONS

1. Please note and strictly adhere to the following Safety Instructions. Additional **Warnings** and **Notices** are printed in this User's Manual; **it is imperative that you read carefully all chapters of this Manual before operating the Breeze**. It is also advisable to refresh your memory by re-reading this Manual periodically.
2. **Get acquainted** with the **Breeze** and its operational features before driving it.
3. **Drive slowly** (Place Speed Selector in position "1/2") until you get used to the **Breeze**, to its various functions, safety features, and to its braking capabilities and limitations.
4. **Watch carefully** for pedestrians and drive your **Breeze** accordingly. In crowded areas always drive with the Speed Selector at Low Speed (position "1/2").
5. Drive **only where permitted** according to all applicable local laws and ordinances.
6. **Never remove any of the Breeze safety** parts like Fenders ,Plastic Covers or Emergency Brake lever .
7. **NEVER Remove** any of the **WARNING Labels** . If any of the Warning labels is removed , got wear , painted etc. ask your dealer to supply you a new labels .
8. **Never put** your hands, fingers , legs into any moving parts or under any protection cover , since moving parts are under covers and heated surfaces as well .
9. Do not release the Manual or Electrical Release Lever of the Electromagnetic Brake when the **Breeze** is on a slope.
10. **Never load** the **Breeze** total loads (User weight and all other loads combined) more than 160Kg (352lbs) .
11. The load in the Rear Basket should not exceed 20kg (44 lbs).
12. Never inflate the **Breeze** tires more than recommended on the tires by the manufacturer.
13. The **Breeze** is designed and built to carry ONE person only on the Single Seat model.
14. **Never** operate it with an additional person on board, not even a child.
15. Do not change the Speed Selector position while driving.
16. **NEVER** use the **Breeze** for climbing up or riding down stairs.
17. If for any reason the **Breeze** does not stop when you release the Operating Lever, or stopped after longer distance than regular or higher than 3 meters (level surface) , immediately use the Hand Brake to stop the **Breeze** and turn the Main Key Switch to "OFF". **Contact your dealer immediately**.
18. **NEVER** use a hose for cleaning. This may severely damage the power and electronic components. Use only a damp cloth and mild detergent.

19. Do not use the **Breeze** neither at heavy rain or extreme humidity conditions nor at temperatures below -30°C (-22°F) or above +45°C (+113°F).
20. Never try to go an obstacle that is more than the maximum recommended slope angle and curb climbing in the specification sheet.
21. The seat weight is 15 Kg (33lbs). Each battery weight 20 Kg (44lbs) and more. Be careful when lifting the seat and the batteries. See instruction for lifting in Chapter 3: Maintenance and Chapter 5: Repair and troubleshooting. **Keep lifting with your Knees/legs and not loading your Back.**
22. **When adjusting/folding** the seat back, armrest, seat sliders (forward / reverse), tiller distance and as well when squeezing the speed lever or hand brake, always be careful that your hands and fingers will not be trapped between any of the adjusting parts .
23. **If the WARNING Led start** flashes while driving, your motor exceeded too high temperature; you should stop the **Breeze** and let the motor cool for a while.
24. **If the Breeze** is involved in any kind of an accidents that part are damaged, it is necessary to check the vehicle by qualified technician before go on using it.
25. **Batteries** contain lead and acid , and should be disposed only to a proper disposal
26. When driving always make sure , that the **backrest is in most upright position** .
27. When climbing an Obstacle drive always so that the **Breeze** Front is toward the obstacle .
28. Be ware from trapping your fingers in the tiller mechanism , when adjusting the tiller – Forward / Reverse .
29. Use gel/dry batteries only.

WARNING !!!

- ✓ Special care must be taken to prevent children from operating the *Breeze*.
- ✓ Always drive carefully , adjust the speed according the limitation of the road.
- ✓ Instability problem can arise when performing turns at high speed . Before making sharp turns , reduce the *Breeze* speed to minimum to prevent side roll-over.
- ✓ The *Breeze* is able to go up slope higher than the recommended safe slope. Do not drive on slopes you are not sure about their angle. However drive very slowly and prevent side driving on such slopes.
- ✓ Never disengaged manually or electrically the electromagnetic parking brake when the vehicle is on a slope.
- ✓ The lights of the *Breeze* should be on when visibility is restricted , either by day or by night.
- ✓ Since that your seat upholstery is Fire resistant, do not cover or replace with other upholstery than an original one.
- ✓ When removing the Batteries cover Be careful from hot parts .The Motor , Transaxle, EMB, Electronic cards and Electronic Box might be wormed , Do not touch them before you make sure about their temperature.
- ✓ Pay attention that your fingers will not be pressed between the squeeze or Brake lever and the Rubber Grip.
- ✓ The seat weight is 15 Kg (33lbs). keep lifting the seat with your Knees/legs and not loading your Back.
Hold the Seat in your two hands – one hand on the backrest and a second hand at the front lower part of the seat and lift the seat up from its pivot.

WARRANTY

AFIKIM ELECTRIC VEHICLES strives continuously to improve its products, their quality and reliability in an incessant effort to ensure its customers' satisfaction as well as its place on the market.

Warranty for the *Breeze* is subject to your local distributors warranty.

1.2 GENERAL DESCRIPTION OF THE *Breeze*

Note: The numbers in parentheses refer to the parts illustrated on Figure 1+2.

Handlebars (1)	Your <i>Breeze</i> is delivered to you with right-hand controls. (Left-hands controls can be setup by your dealer).
Serial No. (1.2)	Serial Number and Manufacturer's data are fixed near the Charging Fuse (2.1C).
Operating lever (1.3)	Use to control the <i>Breeze</i> speed. Standard is right hand (optional left hand).
Charging Socket (1.4)	The socket is used to connect the charger plug for batteries charging. Right hand side of the Handlebar.
Handlebars Adjusting Lever (1.5)	The Handlebar of the <i>Breeze</i> is adjustable Forward and Reverse by releasing the Adjusting Lever.
Buzzer (1.6)	
Front Basket (1.7)	For carrying parcels and personal effects. Maximum load 5 kg (11 lbs).
Headlight and Blinkers (1.8)	(A) Road light for dark hours (B) Blink light for turnings mark
Electric Button to release the Electromagnetic Brake (1.9)	Located on the Handlebar of the <i>Breeze</i> , the Electromagnetic Brake Release button allows free movement of the <i>Breeze</i> . To engage just push the button. To release the brake just leave the button.
Battery Cover (2)	Protect the power unit and electronics.
Fuses (2.1A, 2.1C)	2.1A -Main fuses 70A – Semi Automatic 2.2C –Supply fuse -3A – Semi Automatic (at the electronics box side) 2.1C – Charge fuse 15A–Semi Automatic
Manual Release Lever of Electromagnetic Brake (2.2)	Located under the seat at the rear right of the <i>Breeze</i> , the Electromagnetic Brake Manual Release Lever allows free movement of the <i>Breeze</i> . To release or engage the EMB, Follow the instruction label near.

Seat (3)	The Breeze Seat is equipped with folding armrests (3.4) to allow convenient access to the Seat. The Seat itself can be rotated to allow easy access.
Seat Forward / Reverse Lever (3.1)	The Lever is used to change the seat position Forward and Reverse , to fit the driver mostly.
Seat Rotation Lever (3.2)	The Lever is used to swivel the Seat 45 and 90 degrees in either direction, to ease the driver's access to the Seat.
Seat Height adjust	The Seat Height can be Adjusted Up / Down to fit the user Height. This adjustment can be made by a technician.
Rear Basket (3.3)	For carrying parcels and personal effects. Maximum load 20 kg (44 lbs).
Hand Rest (3.4)	Use for comfort entrance, Folded.
Floor (4)	Carpet covered. Possible to remove for cleaning.

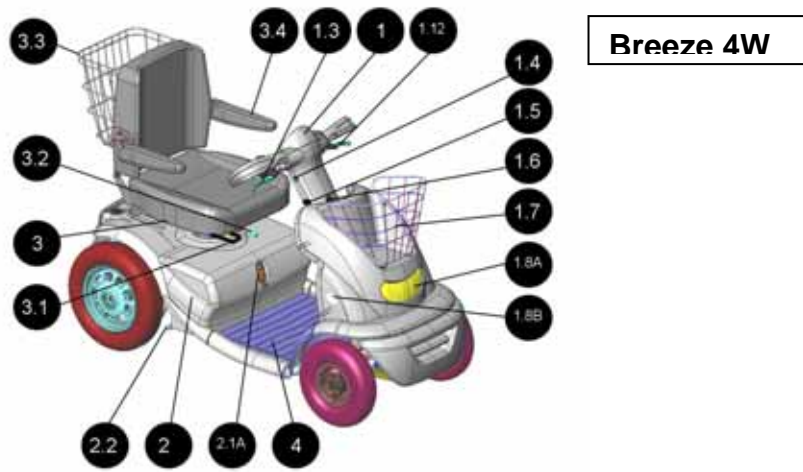

Figure 3

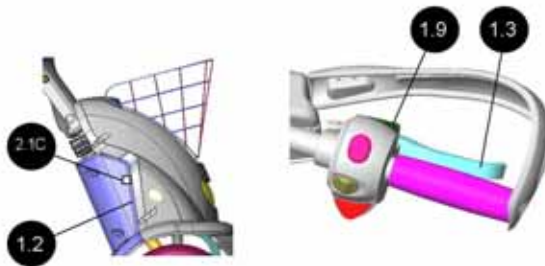
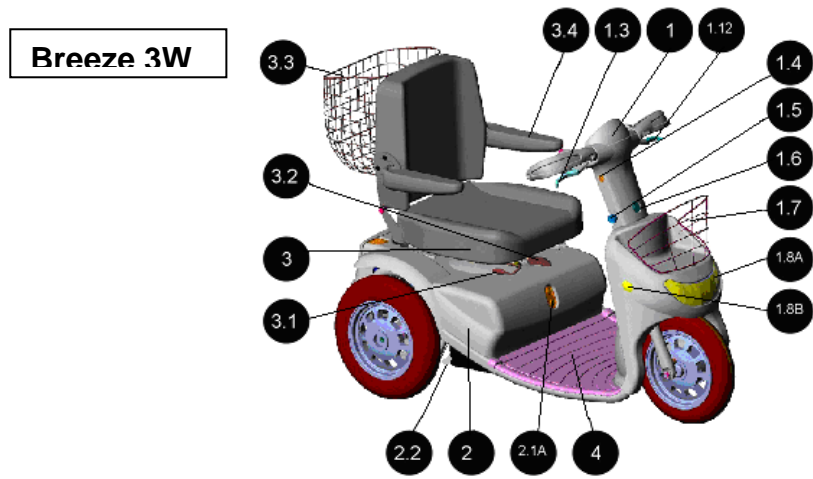

Figure 2

1.3 TECHNICAL SPECIFICATIONS

MODEL No. :		<i>Breeze 4W</i>		<i>Breeze 3W</i>	
Units		Metric	USA	Metric	USA
Dimensions *	Length	154 cm	60.6"	145 cm	57"
	Length with turned Handlebar				
	Width	67 cm	26.4"	67 cm	26.4"
	Folded Height (for transport: folded handlebar and seat removed)	~90 cm	35.4"	~90 cm	35.4"
	Ground clearance	12 cm	5"	12 cm	5"
	Seat Height	38-50cm	15-19"	38-50cm	15-19"
Weights *	Total, without batteries	111 kg	244 lbs	104 kg	228 lbs
	Total, with batteries	155 kg	341 lbs	148 kg	325 lbs
	Maximum User Weight	160 kg	352 lbs	160 kg	352 lbs
	Maximum Weight in front basket	5 kg	11 lbs	5 kg	11 lbs
	Maximum Weight in rear basket	20 kg	44 lbs	20 kg	44 lbs
	Maximum Total load (including front and rear basket load)	160 kg	352 lbs	160 kg	352 lbs
	Batteries weight	2x20kg	2x44 lbs	2x20kg	2x44 lbs
	Seat Weight	15 Kg	33 lbs	15 Kg	33 lbs
Speed **	Forward (Speed selector in 1 pos.)	10 km/h	6.2 mph	10 km/h	6.2 mph
	Forward (Speed selector in 1/2 pos)	5 km/h	3.2 mph	5 km/h	3.2 mph
	Reverse	5 km/h	3.2 mph	5 km/h	3.2 mph
Climbing ability	Maximum slope angle	21%	11.85°	21%	11.85°
	Obstacle climbing ability	12 cm	5"	12 cm	5"
Tires Pneumatic	Front tire size		3-10"		3-10"
	Rear tires size		4.00-6"		4.00-6"
	Pressure (front and rear tires)	2.33 bars	35 psi	2.33bars	35 psi
Batteries	Gel/dry batteries only Dimensions l x b x h	50-70 Ah 280x175x 230mm	2x12 V	50-70 Ah 280x175 x230mm	2x12 V
Travel Distance	Fully charged batteries, level surface, driver 80 kg (176 lbs)	40 km	26.7 miles	40 km	26.7 miles
Charger	For charging Lead Acid Battery	24VDC, Max.12A		24VDC, Max.12A	

Remarks :

All technical specifications are subject to change without prior notice.

All dimensions are in round figures.

- ✓ * Dimensions and weight do not include **Breeze** Canopy.
- ✓ ** The maximum speed can be adjusted by the manufacturer to allow for lower or higher maximum speed (i.e., max. 12 km/h , 8 mph or max 15 km/h - 10mph). The maximum speed at every country is limited according local restrictions.
- ✓ *** Deep cycle batteries. Consult your dealer for other sizes.
- ✓ **** A Maintenance Manual is available for trained technicians.

CHAPTER 2 - ADJUSTMENT & OPERATING INSTRUCTIONS

(Reference numbers refer to the figures at the bottom of the page)

Adjusting the Handlebars (1)	Adjust height/ distance of handlebars as follows: <ul style="list-style-type: none">• Release the Handlebars Adjusting Lever (1.5), which secures the handlebars in place, by pulling the Knob outward.• Release the Knob and insure handlebar lock.
Seating into the Breeze	Before driving the Breeze make sure that the Charging Plug is disconnected from the Charging Socket (1.4). Note: While the Charging Plug is inserted in the Charging Socket, the Breeze cannot be operated. Lift the Lever (3.2) upward, rotate the Seat and raise the Armrest (3.4) to give you easy access to the Seat. Adjust the seat Forward Reverse using the Lever (3.1)

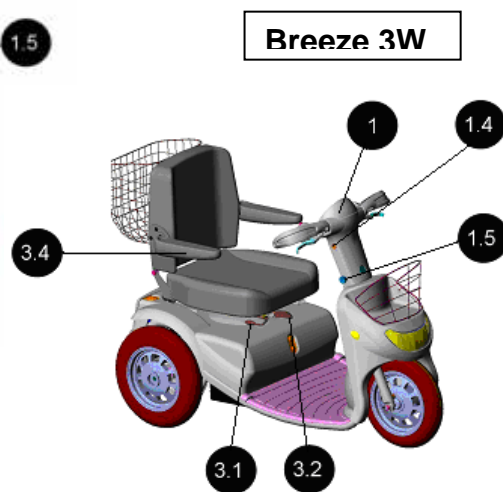

Figure 3

(Numbers in the table refers to figure no.4)

Key Switch	<p>The Breeze has a Main Key Switch (1.17) - located on the backside of the Tiller Box (1). The Main Key Switch has two positions: “OFF” - The Breeze cannot be driven and the Electromagnetic Brake is locked. “ON” - Power is supplied to the Breeze. The Electromagnetic Brake releases automatically when the Operating Lever is squeezed. To operate the Breeze, insert the key into the Main Key Switch and turn it to “ON” (clockwise). The switch will remain in this position and the green (5.2) light will be lit. <u>Remark</u> : Key Switch is used for operating the Breeze , but not for locking .</p>
Automatic Shut Off	<p>When Key Switch is at “ON” position, after a few minutes (about 20 minutes) without using the Operating Lever, the control system will be shut off automatically to save battery energy. In such cases, to restart control system, turn Main Key Switch “OFF” and “ON” again.</p>
Battery Status Indicator	<p>The Battery Status Indicator (5.1) located on top of the Tiller Box shows you the remaining capacity of the batteries. When the indicator shows that mid-half capacity remains, recharge batteries as soon as possible. When the indicator points that to first or second segment on the left there are only about 5 km (3 miles) to go.</p>
Fault Indicator	<p>The Battery Status Indicator (5.1) is used also as a Fault indication. When the Leds are flashing, the number of lit Leds are the code of the fault . (See Maintenance Manual for code definition).</p>

Forward/Reverse Selector	<p>The Forward/Reverse Selector (1.10) is located on the handlebar. Select the desired direction (as marked). In reverse mode, a warning buzzer sounds automatically (in certain models only and subject to local ordinances).</p> <p>Warning: Do not change Selector position while the <i>Breeze</i> is in motion.</p>
Adjusting the Hand Brake (1.12)	<p>The hand brake cable mechanism can be adjusted by an authorized serviceman, dealer or by any professional authorized to adjust hand brakes mounted on bicycles or motorcycles.</p> <p>The Hand Brake is part of your safety system. DO NOT adjust the Hand Brake by yourself - get professional assistance!</p>

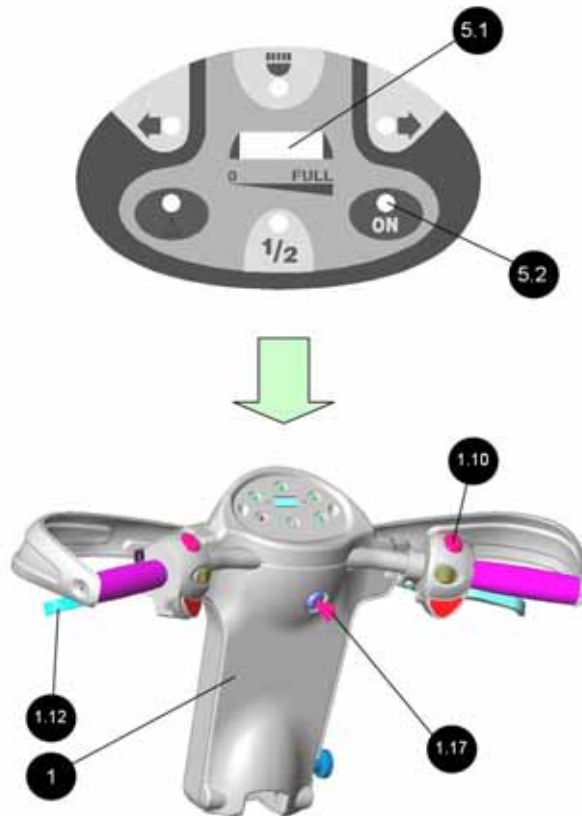

Figure 4
15

(Numbers in the table refers to figure no.5)

<p>Speed Range Selector</p>	<p>The Speed Range Selector (1.11) is located on the handlebar. It has two positions:</p> <ul style="list-style-type: none"> • Mark “1/2”: Low speed –up to 5 km/h(3.2 mph). • Mark “1”: High speed – 10 km/h (6.5 mph). <p>Do not shift the selector while the Breeze is in motion.</p> <p>Notes:</p> <ol style="list-style-type: none"> 1. When driving the Breeze inside a building or in a crowded area, use only position “1/2” (Low speed). 2. When Low speed - position “1/2” is used , the Led (7) will lit. 3. The max speeds 12 and 15 km/h in related models .
<p>Operating Lever and Manual Hand Brake</p>	<p>To start driving, squeeze the Operating Lever(1.3) gently until you reach the desired speed.</p> <p>The speed is directly proportional to the deflection of this Lever .</p> <p>To stop - release the Operating Lever (1.3). The Breeze will stop gradually.</p> <p>Additionally, emergency braking is possible using the Manual Hand Brake (1.12). Squeeze Hand Brake (Red).</p>
<p>Panic Brake</p>	<p>The Operating speed lever (1.3) is equipped with Panic switch, which is operated when squeezing the Speed lever very strongly (higher than 8 Kg (18 lbs). At that condition, the Breeze will brake and stop. To reset the driving you need to switch off, wait 5 seconds and switch on the main key switch again.</p>
<p>Signaling</p>	<p>Before turning, shift the “Turn Signal Switch” (1.15), on the Handlebar to the desired direction - left for left, right for right.</p> <p>To stop the signal lights just Push the switch knob forward. This will stop the blinking lights.</p> <p>While blinkers light are activated, the Right (5.3) /</p>

	Left(5.4) Leds signing will operate respectively. A warning buzzer also sounds (in certain models only and subject to local ordinances).
Horn/Buzzer (in certain models only)	<p>Push one of the 2 Buttons (1.14) activates the buzzer.</p> <p>The buzzer sounds automatically under the following conditions (<i>subject to change where prohibited by law</i>):</p> <ol style="list-style-type: none"> 1. When reversing. 2. When operating the "Turn Signal Switch" (Right or Left). <p><u>Remark</u>: It is possible to change the Buzzer Functioning by changing a Dip Switch in the front Board .This have to be made by a trained technician.</p>
Headlight Switch	<p>Turn on the Headlight with Light Switch (1.13). This switch activates both the Headlight and the Rear Lights.</p> <p>When Lights are activated the Light Led (5.6) is lit.</p>
Hazard Warning	<p>The Hazard Button (1.16) operates all flashing lights on the Breeze. Pushing the button once turns the lights ON.</p> <p>A second push turns them OFF.</p> <p>When Hazard is activated all signaling Leds (5.3+5.4+5.6) are Flashing.</p>
Charge Inhibit / Motor overheated Condition Indicator (5.9)	<p>When the Vehicle is being charged it is inhibited. In this condition the Inhibit Led (5.6) lit and no driving can be done.</p> <p>Also when the motor is overheated the Led (5.6) will blink. At this condition it is recommended to stop the Breeze and let the motor cool for a while.</p>

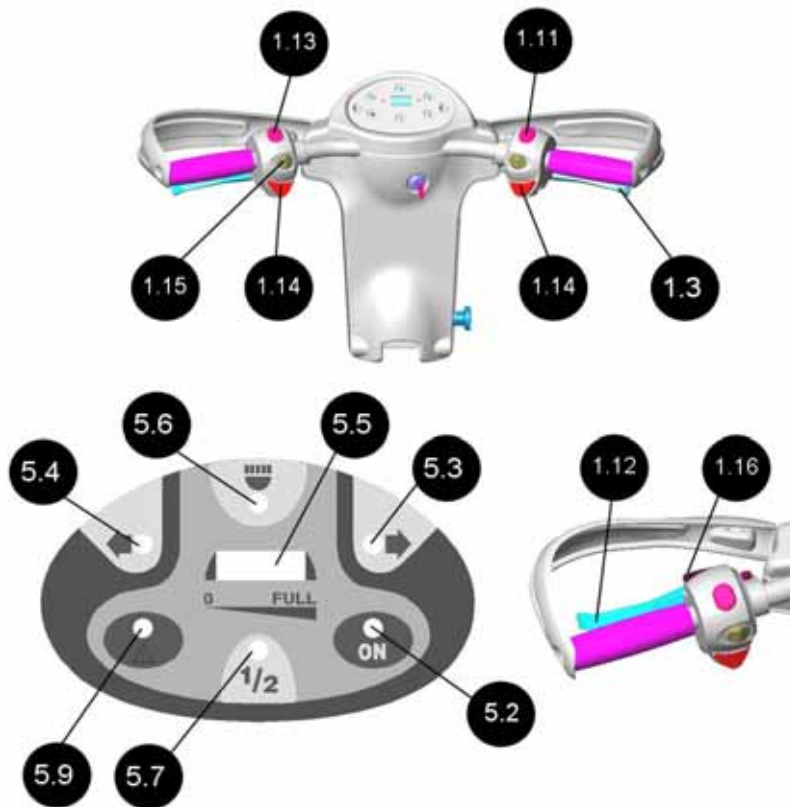
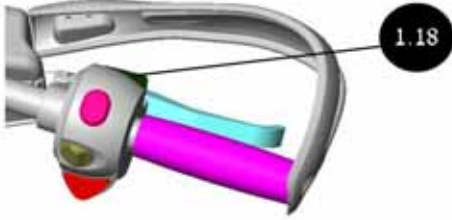



Figure 5

Parking	<p>After stopping, turn the Main Key Switch to OFF and remove the key. The ON lights will turn OFF. The Electromagnetic Brake is engaged (locked).</p> <p>Note: The Electromagnetic Brake is automatically locked whenever the Operating Lever is released and after the <i>Breeze</i> stops completely.</p>
Safe driving	<p>When driving on Ramp , Steep Curbs , Step and turns drive the Breeze very slowly and carefully , even consider changing the speed switch (1.11) to “1/2” position : Low speed .</p> <p>When going up or down a step always drive the Breeze so that the wheels will get in perpendicular</p>

	<p>direction to the step and the rear wheels wheel climb or go down together. Never try to go on an obstacle that is more than the maximum recommended slope angle and curb climbing is in the specification sheet.</p> <p>Always drive carefully , adjust the speed according the limitation of the road. Before making sharp turns , reduce the <i>Breeze</i> speed to minimum to prevent side roll-over.</p>
<p>Electric Button to release the Electromagnetic Brake (1.18) See figure</p>	<p>Located on the Handlebar of the <i>Breeze</i>, the Electromagnetic Brake Release button allows free movement of the <i>Breeze</i>. To release, simply push the button. To engage brake, Just release the button. The Button will operate only when the KeySwitch is at ON position.</p> 
<p>Climbing an Obstacle</p>	<p>To climb an Obstacle drive the <i>Breeze</i> forward, toward the Obstacle. Drive until that the front wheel is touching the obstacle and than squeeze the lever speed , keeping the direction .</p>
<p>Driving on slopes and Turns</p>	<p>and especially on slopes . Before making sharp turns , reduce the <i>Breeze</i> speed to minimum to prevent side roll-over. The <i>Breeze</i> is able to go up slope higher than the recommended safe slope. Do not drive on slopes you are not sure about their angle. However drive very slowly and prevent side driving on</p>

	
Pre-use	<p>Now after learning through all the operating instructions, before starting to use the Breeze, do a visual check through the all the parts of the vehicle, to make sure that no external damage has been occur to the vehicle while transportation. In any case you are not sure call your dealer and ask for an explanation.</p>
Controller Programming	<p>Several parameters of the Breeze Controller can be programmed with a special Programmer. Programming should be done by trained authorized technician only. Wrong programming can cause abnormal operation of the Breeze ,Harm persons and Injury.</p>
Performance check	<p>It is very much recommended that when receiving as new or from another user or after a period of not using the Breeze a performance check will be made as follows:</p> <ol style="list-style-type: none"> 1. Switch on the main switch. 2. See that on the display panel – the battery indicator is lit and the Ready/ON led is lit as well. 3. Squeeze the speed lever slowly and make sure that the Breeze is traveling with correspondence to the squeezing on the lever. 4. Release the lever and make sure that the Breeze is stopping softly and that you hear a click coming from the EMB engaging. 5. Make a check of all the buttons functions on the handlebar. 6. Switch off the main key switch. Your Breeze is now ready to drive.

Pre-use measures	The user should know his weight and all other loads is lower than the maximum of 160 Kg (352lbs). If not sure it should be measured.
Safety Belt Assembling (option)	If a safety belt is needed. Secure a standard car Safety belt to the seat armrest securing bolts (See 3.5 on Figure 6).
Attaching the Breeze in motor vehicle for transportation	To transport the Breeze in a motor vehicle , the Breeze has to be secured while traveling . The Foot rest of the Breeze should be tie down (6) to the motor vehicle floor with a suitable restrain belts and tight systems. The Rear part of the Breeze should be tie down (7) as at the 2 Yellow Marks at the rear part of the Breeze -in the lower part of the power unit . The tie/restrain system should be with similar components and securing ,like the ones used in standard cars fasten belt.
Transportation	To reduce the height of the Breeze while transporting it , The seat can be removed as explained in chapter 3 : maintenance , And as well the Tiller can be folded to horizontal position . <div data-bbox="683 846 1098 1216" data-label="Image"> </div> <p data-bbox="847 1245 963 1279" style="text-align: center;">Figure 6</p>
Shock Absorbers Adjust	It is possible to adjust the Shock Absorbers according to the User Weight. Adjusting the shock absorber can be done by a technician only

CHAPTER 3 - MAINTENANCE

Note:

1. Maintenance Manual is available for trained technicians.
2. The numbers in parentheses refer to the parts illustrated in figure 7.

Although the **Breeze** requires minimal maintenance, do not neglect it. When servicing the **Breeze**, make sure that it stands on a level surface and that the key is not inserted.

- ✓ **Remark:** For the periodic maintenance no special tooling is needed .
(Numbers in the table refers to figure no.7)

Periodic Maintenance Check	No.	Type of Service	Frequency
	1	Check for missing parts and damaged parts .Use the figures #1,2,3,4 .	When receiving the Breeze or after a long time not using it.
	2	Check air pressure in all tires.	Every two weeks
Note: To check the batteries, the Gray Cover located under the Seat must be removed.			
Removing the Seat and the Gray Cover (2)	Turn the Seat by using the lifting Lever (3.2) so that the Lever will point 45° Right or Left. The Seat can be removed only at this position. Remove the Seat (3): Hold the Seat in your two hands – one hand on the backrest and a second hand at the front lower part of the seat and lift the seat up from its pivot. Warning! The seat weight is 15 Kg (33lbs). Keep lifting with your Knees/legs and not loading your Back. Release Gray Cover (2) securing screws (2.3). Lift the Gray Cover (2) until it is released from the Seat Pivot(4).		
Replacing the Gray Cover (2)	The replacement of the Gray Cover is done in reverse order; MAKE SURE that the Gray Cover (2) fits onto it's place. Secure with 2 screws (2.3).		

Batteries	Batteries weight each ~20 Kg (~44lbs) and over. Lift each battery only with the appropriate handle. Keep lifting with your Knees/legs and not loading your Back.
Tires	Correct air pressure in the tires is essential for optimal steering and stability of the Breeze . Check air pressure every two weeks. Inflate to the proper air pressure (35 psi).
Cleaning	Use only a damp cloth and mild detergent. Never use a hose for cleaning. This may severely damage the power and electronic components.

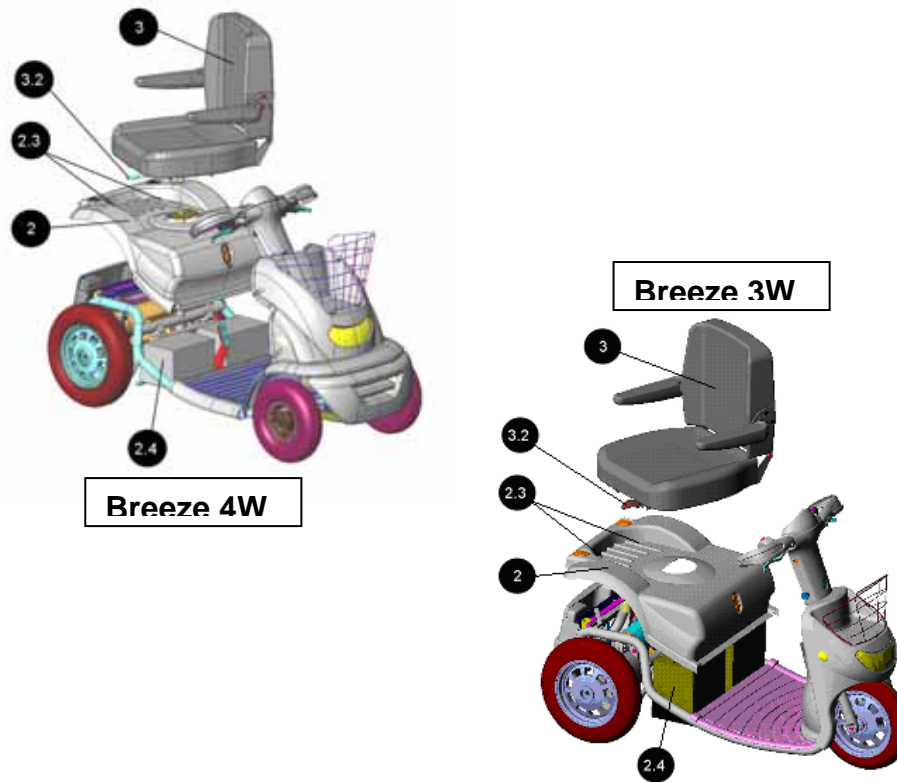

Figure 7

CHAPTER 4 - CHARGING

Read Charger's manual before using the charger..

Warning: If you use a different charger, ask your dealer for instructions.

CHARGING BATTERIES (See figure 8)

1. Insert first the Charging Plug (8) to the Charging Socket (9) located at the right side of the tiller box.
2. Plug the power cord (10) of the charger into a wall outlet (11).
3. When charging is completed and you are ready to go - unplug the charger cord (10) from the wall outlet (11) and then remove the charger plug (8) from the **Breeze** charging socket (9).
4. In ideal storage conditions, batteries which were charged to full capacity and were not used should be recharged every 6 months.
5. If you are planning not to use your **Breeze** for an extended period of time, we recommend charging it for two days and then disconnecting the batteries.
6. If you have not used your **Breeze** for an extended period of time, charge the batteries for at least 24 hours before driving.

- **Note: There is NO need to disconnect the Charging Plug promptly after the charging is complete.**
- **However, DO NOT leave the Charger connected to the batteries FOR MORE THAN TWO WEEKS.**
- **As long as the Charging Plug is in the Charger Socket, the electronic control of the **Breeze** automatically cuts all power to the electric system and the **Breeze** cannot be driven.**

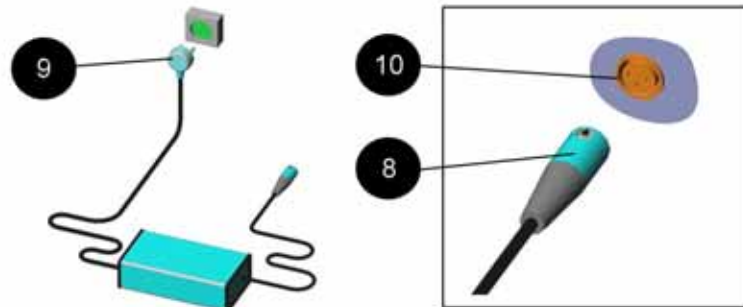

Figure 8. Charging batteries

CHAPTER 5 - TROUBLESHOOTING AND FAULT REPAIR

The following table provides troubleshooting and repair instructions for symptoms encountered when operating the **Breeze**. It presents the best ways to handle the faults. The table contains three columns:

The Symptom - describes the functional problem that results from the fault.

Probable Cause - lists all probable causes for the relevant symptom. The probable causes are listed logically by order of probability: the first one is the most probable.

Remedy - lists the action to be taken to solve the problem. The appropriate remedy appears opposite each probable cause. These remedies should solve the problem; if not, continue down the list to the next cause/remedy.

Remember: you may contact your dealer at any time for further professional support.

Remark:

- ❖ For the troubleshooting repairing, the only **tools** needed are regular and Philips screwdrivers to open the rear lights covers, to replace the bulbs if burnt.
- ❖ **Replacement parts:**
 - Front tire and tubes: 3-10"
 - Rear tires and tubes: 4.00-6"
 - Headlight bulb: Two filaments 12V/18W/18W (for motorcycle headlights)
 - Front Blinker : 24V/5W
 - Rear light bulbs: Upper Marking – 24V/10W – bionet socket
 - Mid flashing – 24V/10W – bionet socket
 - Lower Stop – 24V/5W – banana socket

TROUBLESHOOTING AND FAULT REPAIR

No.	Symptom	Probable Causes	Remedy
1	Flat tire and unstable driving.	<ul style="list-style-type: none"> ✓ Low air pressure. ✓ Puncture. 	<ul style="list-style-type: none"> ✓ Pump to normal pressure. ✓ Repair the punctured tire.
2	The Display Flashes and the vehicle does not move.	<ul style="list-style-type: none"> ✓ Controller Coded Fault. 	<ul style="list-style-type: none"> ✓ Ask for technical Assistance.
3	The inhibit Led lit	<ul style="list-style-type: none"> ✓ Breeze is in charge 	<ul style="list-style-type: none"> ✓ Remove charging plug from charging socket.
4	Manual Mechanical Brake Lever is fully pressed but the vehicle does not stop.	<ul style="list-style-type: none"> ✓ Loose hand brake mechanism. 	<ul style="list-style-type: none"> ✓ Tighten the brake cable.
5	When releasing the speed lever on level surface , the Breeze does not stop at regular distance or more than 3 meters	<ul style="list-style-type: none"> ✓ Not adjusted or faulty controller or. 	<ul style="list-style-type: none"> ✓ Ask for technical assistance.
6	The Key Switch is turned to "ON" (clockwise), but the "ON" light does not come on.	<ul style="list-style-type: none"> ✓ Main fuse popped out or electrical fault . 	<ul style="list-style-type: none"> ✓ Reset fuse <p>Note:Do not reset fuse more than twice. If the symptom recurs after resetting the second time, call the authorized dealer for further technical support.</p>

TROUBLESHOOTING AND FAULT REPAIR (Cont.)

No.	Symptom	Probable Causes	Remedy
7	Breeze does not move when squeezing the Operating Lever .	<ul style="list-style-type: none"> ✓ Main Key Switch is in OFF position. ✓ Charging Plug is installed in Charging Socket. ✓ The Mechanical Release Lever of the Electromagnetic Brake is operated . ✓ Control system failure. 	<ul style="list-style-type: none"> ✓ Turn the key to "ON" position. ✓ Disconnect the Charging Plug from the Breeze. ✓ Remove lever to engaged position . ✓ Call for technical support.
8	Intermittent drive.	<ul style="list-style-type: none"> ✓ Battery capacity low. ✓ Failed connections ✓ Faulty battery. 	<ul style="list-style-type: none"> ✓ Charge batteries for at least 18 hours. ✓ Remove Gray Cover and check the battery cables connection. In case of corrosion of the terminals, clean the terminals with a damp clean cloth. ✓ If, after recharge, the red leds are still ON, the battery may be faulty. For replacement, contact your dealer.
9	RIGHT or LEFT turn signal light is inoperative.	<ul style="list-style-type: none"> ✓ Burnt out bulb. 	<ul style="list-style-type: none"> ✓ Replace bulb.
10	Headlight and/or rear light are not lit.	<ul style="list-style-type: none"> ✓ Burnt out bulb. 	<ul style="list-style-type: none"> ✓ Replace Headlight or Rear bulb.

11	If the WARNING led start flashes while driving (see figure 5-(5.9))	✓ The Breeze motor exceeded too high temperature.	✓ You should stop the Breeze and let the motor cool for a while.
12	When driving uphill or carrying heavy loads the Breeze speed is decreased gradually but still moving.	✓ The Breeze controller exceeded too high temperature.	✓ It is recommended to stop the Breeze and let the controller cool for awhile.

CHAPTER 6 - EMI WARNING

All types of electrically powered vehicles, such as powered wheelchairs and motorized scooters (in this text all types will be referred to as “powered vehicles”) may be susceptible to electromagnetic interference (EMI). This is from sources such as radio and TV stations, amateur radio (HAM) transmitters, two-way radios and cellular phones. The interference (from radio wave sources) can cause the powered vehicle to release its brakes, move by itself, or move in unintended direction. It can also damage the powered vehicle’s control system. The intensity of the interfering EM energy can be measured in volts per meter (V/m). Each powered vehicle can resist EMI interfering electromagnetic energy (EM) emitted up to a certain intensity. This is called its “immunity level”. The higher the immunity level, the greater the protection. At this time, current technology is capable of achieving immunity level, which would provide useful protection from the more common sources of radiated EMI. This vehicle as shipped, with no further modification, has an immunity level of 20 V/m.

There are a number of sources of relatively intense electromagnetic fields in everyday environment. Some of these sources are obvious and easy to avoid. Others are not apparent and exposure is unavoidable. However, we believe that by following the warning listed below, your risk of EMI will be minimized.

The sources of radiated EMI can be broadly classified into three types:

1. Hand-held portable transceivers (transmitters-receivers) with the antenna mounted directly on the transmitting unit. Examples include: citizen band (CB) radios, “walkie talkies”, security, fire and police transceivers, cellular telephones and other personal communication devices. ** NOTE: some cellular telephones and similar devices transmit signals while they are ON, even when not being used.
2. Medium-range mobile transceivers Such as those used in police cars, fire trucks, ambulances and taxis. These usually have the antenna mounted on the outside of the vehicle .
3. Long-range transmitters and transceivers such as commercial broadcast transmitters (Radio and TV broadcast antenna towers) and amateur (HAM) radios.

NOTE: Other types of hand held devices, such as cordless phones, laptop computers, AM/FM radios, TV sets, CD players, cassette players and small appliances such as electric shavers and hair dryers,

as far as we know, are not likely to cause EMI problems to your powered vehicle.

Powered Vehicle Electromagnetic Interference (EMI)

Because EM energy rapidly becomes more intense as one moves closer to the transmitting antenna, the EM field from hand-held radio wave sources (transceivers) are of special concern. It is possible to unintentionally bring high levels of EM energy close to the powered vehicle's control system while using these devices. This can affect powered vehicle movement and braking.

Therefore, the warnings listed below are recommended to prevent possible interference with the control system of the powered vehicle.

WARNINGS

Electromagnetic interference (EMI) from sources such as radio and TV stations, amateur radio (HAM) transmitters, two-way radios and cellular phones can affect powered vehicles.

Following the warnings listed below should reduce the chance of unintended brake release or powered vehicle **movement which could result in serious injury:**

- 1) Do not operate hand-held transceivers (transmitters-receivers) such as citizen band (CB) radios, or turn ON personal communication devices such as cellular phones, while the powered vehicle is ON;
- 2) Be aware of nearby transmitters, such as radio or TV stations and try to avoid coming close to them.
- 3) On appearance of unintended movements or brake release occurrences, switch the powered vehicle OFF **as soon as it is safe.**
- 4) Be aware that adding accessories or components, or modifying the powered vehicle, may make it more susceptible to EMI (Note: there is no easy way to evaluate their effect on the overall immunity level of the powered vehicle).
- 5) Please report to us all incidents of unintended movement or brake release and note whether there is a source of EMI nearby.

Important information

- 1) 20 volts per meter (V/m) is a generally achievable and useful immunity level against EMI (as of May 1994). The higher the level the greater the protection;
- 2) This product delivered to you, has an immunity level of 20 V/m.