



DIGESTIVE
HEALTH
ENTERAL
FEEDING
PRODUCTS



HALYARD* MIC-KEY* INTRODUCER KIT

HALYARD* MIC-KEY* Introducer Kits provide physicians with an innovative solution to facilitate the primary placement for balloon-retained enteral feeding tubes.

HALYARD* MIC-KEY* G INTRODUCER KITS

- Kits include tools and devices to facilitate primary placement of MIC-KEY* G and MIC* G Enteral Feeding Tubes
- Pre-loaded SAFE-T-PEXY* T-Fasteners
- Resorbable 3/0 Biosyn* Suture
- Locking Polyurethane Suture Lock
- Serial Dilator with Peel-away Sheath
- Safety features on Scalpel and Introducer Needle to prevent inadvertent needle sticks
- J-Tip Guidewire
- Over the Wire Stoma Measuring Device for accurate measurement of stoma tract length
- 6ml Syringe
- Ethylene Oxide (ETO) Sterilised

Feeding tube not included in kit.

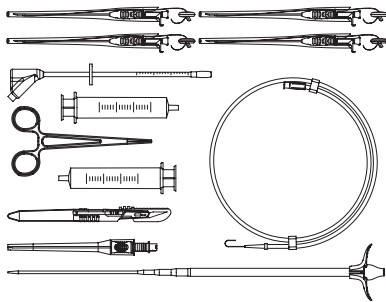

Code	Description	Packaging
98430	Introducer Kit for Gastrostomy Feeding Tube, for use with: 12 Fr MIC* Tube, 12 Fr MIC-KEY* Tube, 14 Fr MIC-KEY* SF Tube. Tube not included.	1 kit/case
98431	Introducer Kit for Gastrostomy Feeding Tube, for use with: 14 Fr MIC* Tube, 14 Fr MIC-KEY* Tube, 16 Fr MIC-KEY* SF Tube. Tube not included.	1 kit/case
98432	Introducer Kit for Gastrostomy Feeding Tube, for use with: 16 Fr MIC* Tube, 16 Fr MIC-KEY* Tube, 18 Fr MIC-KEY* SF Tube. Tube not included.	1 kit/case
98433	Introducer Kit for Gastrostomy Feeding Tube, for use with: 18 Fr MIC* Tube, 18 Fr MIC-KEY* Tube, 20 Fr MIC-KEY* SF Tube. Tube not included.	1 kit/case
98434	Introducer Kit for Gastrostomy Feeding Tube, for use with: 20 Fr MIC* Tube, 20 Fr MIC-KEY* Tube. Tube not included.	1 kit/case

HALYARD* MIC-KEY* J / TJ INTRODUCER KITS

Kit includes:

- Pre-loaded SAFE-T-PEXY* T-Fasteners
- Resorbable 3/0 Biosyn* Suture
- Locking Polyurethane Suture Lock
- Serial Dilator with Peel-away Sheath
- Safety features on Scalpel and Introducer Needle to prevent inadvertent needle sticks
- Seeking Catheter 0.38", 0.97mm Guidewire Compatible
- Over the Wire Stoma Measuring Device for accurate measurement of stoma tract length
- 6ml Syringe
- Ethylene Oxide (ETO) Sterilised

Feeding tube not included in kit.

Code	Description	Packaging
98437	Introducer Kit for Jejunal/Transgastric- Jejunal Feeding Tube, for use with: 16 Fr MIC* Tube, 16 Fr MIC-KEY* Tube. Tube not included.	1 kit/case
98438	Introducer Kit for Jejunal/Transgastric- Jejunal Feeding Tube, for use with: 18 Fr MIC* Tube, 18 Fr MIC-KEY* Tube. Tube not included.	1 kit/case

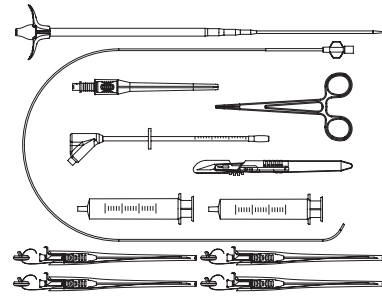

HALYARD* MIC* INTRODUCER KIT COMPONENTS



Code	Description	Packaging
98702	HALYARD* 16Fr Serial Dilator, single Recommend using with 12 Fr Feeding Tube	1 each
98703	HALYARD* 18Fr Serial Dilator, single Recommend using with 14 Fr Feeding Tube	1 each
98704	HALYARD* 20Fr Serial Dilator, single Recommend using with 16 Fr Feeding Tube	1 each
98705	HALYARD* 22Fr Serial Dilator, single Recommend using with 18 Fr Feeding Tube	1 each
98706	HALYARD* 24Fr Serial Dilator, single Recommend using with 20 Fr Feeding Tube	1 each

Code	Description	Packaging
98701	HALYARD* SAF-T-PEXY* T-Fasteners plus Curved Haemostat	1 pack of 3

NOTE: Please see package inserts for directions for use for each of these products.

ENTERAL FEEDING

HALYARD* MIC* PERCUTANEOUS ENDOSCOPIC GASTROSTOMY (PEG) FEEDING TUBES / KITS

- Medical grade silicone construction
- SECUR-LOK* External Retention Ring
- Universal and Bolus Feeding Port Connectors
- Medication Port
- Collapsible Internal Retention Bumper
- Radiopaque Stripe and Bumper
- Tubing Clamp
- Available in Push (OTW) and Pull placement methods
- Ethylene Oxide (ETO) Sterilised

Deluxe 0630-XX Series PUSH PEG Kit Includes:

- 1- Traction removable PUSH PEG tube
- 1- 5 Fr Retrieval Snare (1.8mm x 260cm)
- 1- 0136-XX Bolus Feeding Adapter
- 1- 0137-XX Threaded Feeding Adapter
- 1- SECUR-LOK* External Retention Ring
- 1- 22ga x 1.5", 3.81cm Filter Needle
- 1- 25ga x 1.5875cm Needle
- 1- 25ga x 1.5875cm Needle
- 1- Fenestrated Drape with Adhesive Tabs
- 1- 12ml Syringe
- 1- Disposable Scalpel with #11 Blade
- 1- 14ga x 2.75", 6.985cm Introducer Needle
- 1- Guidewire (.038" x 260cm)
- 1- Tubing Clamp
- 4- 4" x 4", 10.16cm x 10.16cm Gauze Pads
- 2- 2" x 2", 5.08cm x 5.08cm in Slit Gauze Pads
- 1- Suture Strand
- 1- Directions for Use



Deluxe 0640-XX Series PULL PEG Kit Includes:

- 1- Traction Removable PULL PEG Tube
- 1- 5 Fr Retrieval Snare (1.8mm x 260cm)
- 1- 0136-XX Bolus Feeding Adapter
- 1- 0137-XX Threaded Feeding Adapter
- 1- SECUR-LOK* External Retention Ring
- 1- 22ga x 1.5", 3.81cm Filter Needle
- 1- 19ga x 1.5", 3.81cm Filter Needle
- 1- 25ga x 1.5875cm Needle
- 1- Fenestrated Drape with Adhesive Tabs
- 1- 12ml Syringe
- 1- Disposable Scalpel with #11 Blade
- 1- 14ga x 2.75", 6.985cm Introducer Needle
- 1- Looped Placement Wire
- 1- Tubing Clamp
- 4- 4" x 4", 10.16cm x 10.16cm Gauze Pads
- 2- 2" x 2", 5.08cm x 5.08cm in Slit Gauze Pads
- 1- Suture Strand
- 1- Directions for Use

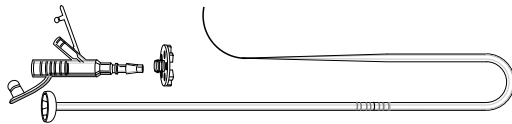

PUSH

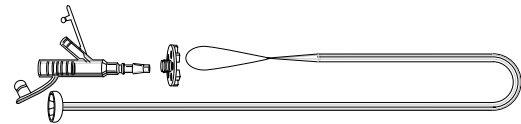

PULL

Code	Size (Outer Diameter)	Description	Packaging
0630-14	14 Fr	PUSH (Over-the-Wire) Method	1 each
0630-20	20 Fr	PUSH (Over-the-Wire) Method	1 each
0630-24	24 Fr	PUSH (Over-the-Wire) Method	1 each

Code	Size (Outer Diameter)	Description	Packaging
0640-14	14 Fr	PULL Method	1 each
0640-20	20 Fr	PULL Method	1 each
0640-24	24 Fr	PULL Method	1 each

Deluxe 0644-XX Series Basic PULL PEG Kit Includes:

- 1- Traction Removable PULL PEG Tube
- 1- 0136-XX Bolus Feeding Adapter
- 1- 0137-XX Threaded Feeding Adapter
- 1- SECUR-LOK* External Retention Ring
- 1- Disposable Scalpel with #11 Blade
- 1- 14ga x 6.985cm (2.75") Introducer Needle
- 1- Looped Placement Wire
- 1- Tubing Clamp
- 1- Directions for Use

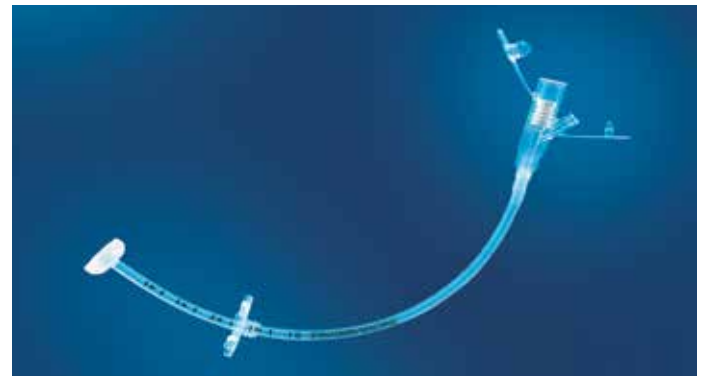

Code	Size (Outer Diameter)	Description	Packaging
0644-14	14 Fr	Basic PULL Peg Kit	1 each
0644-20	20 Fr	Basic PULL Peg Kit	1 each
0644-24	24 Fr	Basic PULL Peg Kit	1 each

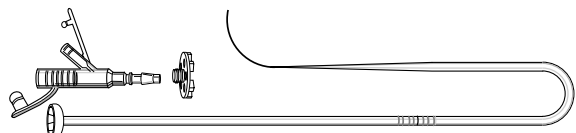

NOTE: Please see package inserts for directions for use for each of these products.

HALYARD* MIC* PERCUTANEOUS ENDOSCOPIC GASTROSTOMY FEEDING TUBE ACCESSORIES

For use with MIC* Percutaneous Endoscopic Gastrostomy Feeding Tubes.

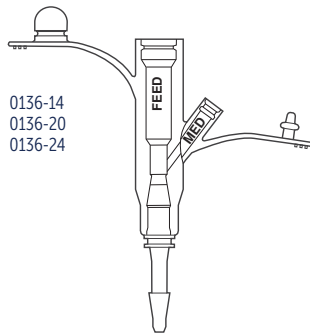
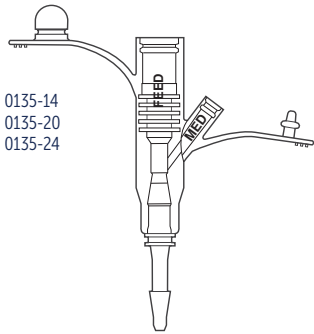

Code	Description	Packaging
0135-14	Universal Feeding Adapter – for use with 14 Fr MIC* PEG	1 each
0135-20	Universal Feeding Adapter – for use with 20 Fr MIC* PEG	1 each
0135-24	Universal Feeding Adapter – for use with 24 Fr MIC* PEG	1 each
0136-14	Bolus Feeding Adapter – for use with 14 Fr MIC* PEG	1 each
0136-20	Bolus Feeding Adapter – for use with 20 Fr MIC* PEG	1 each
0136-24	Bolus Feeding Adapter – for use with 24 Fr MIC* PEG	1 each

HALYARD* MIC* GASTROSTOMY FEEDING TUBES

- Soft Square Skin Disc
- ISO Colour Size Compliant Balloon Ports
- Recessed Distal Tip
- Medical Grade Silicone Construction
- Inflatable Silicone Internal Retention Balloon
- Universal Feeding Port Connector
- Medication Port
- Radiopaque stripe
- Gamma Sterilised



Code	Size (Outer Diameter)	Bal Port Colour	Balloon Volume	Packaging
0112-14LV	14 Fr	Green	3–5ml Balloon	1 each
0112-16LV	16 Fr	Orange	3–5ml Balloon	1 each
0112-18	18 Fr	Red	7–10ml Balloon	1 each
0112-20	20 Fr	Yellow	7–10ml Balloon	1 each
0112-22	22 Fr	Blue	7–10ml Balloon	1 each
0112-24	24 Fr	Purple	7–10ml Balloon	1 each



- SECUR-LOK* External Retention Ring
- White Balloon Ports
- Recessed Distal Tip
- Medical Grade Silicone Construction
- Inflatable Silicone Internal Retention Balloon
- Universal Feeding Port Connector
- Medication Port
- Radiopaque stripe
- Gamma Sterilised

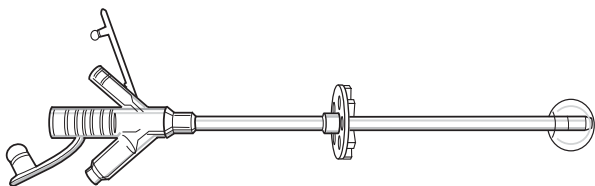

Code	Size (Outer Diameter)	Bal Port Colour	Balloon Volume	Packaging
0100-12LV	12 Fr	White	3–5ml Balloon	1 each
0100-14LV	14 Fr	White	3–5ml Balloon	1 each
0100-16LV	16 Fr	White	3–5ml Balloon	1 each
0100-18	18 Fr	White	7–10ml Balloon	1 each
0100-20	20 Fr	White	7–10ml Balloon	1 each
0100-22	22 Fr	White	7–10ml Balloon	1 each
0100-24	24 Fr	White	7–10ml Balloon	1 each
0100-26	26 Fr	White	7–10ml Balloon	1 each
0100-28	28 Fr	White	7–10ml Balloon	1 each
0100-30	30 Fr	White	7–10ml Balloon	1 each

HALYARD* MIC* BOLUS GASTROSTOMY FEEDING TUBES

- Medical Grade Silicone Construction for visibility and drapability
- Clearly marked feeding, medication and balloon ports for ease of identification
- Ventilated external retention ring designed to allow air to circulate around the stoma site and to reduce pressure 360° from the stoma
- Radiopaque stripe to aid in catheter visualisation
- Graduated centimetre markings for tube position verification
- LUER-LOK* balloon port to ensure secure syringe connection (also compatible with LUER-SLIP* syringes)
- Colour-coded balloon port according to catheter French size for ease of identification

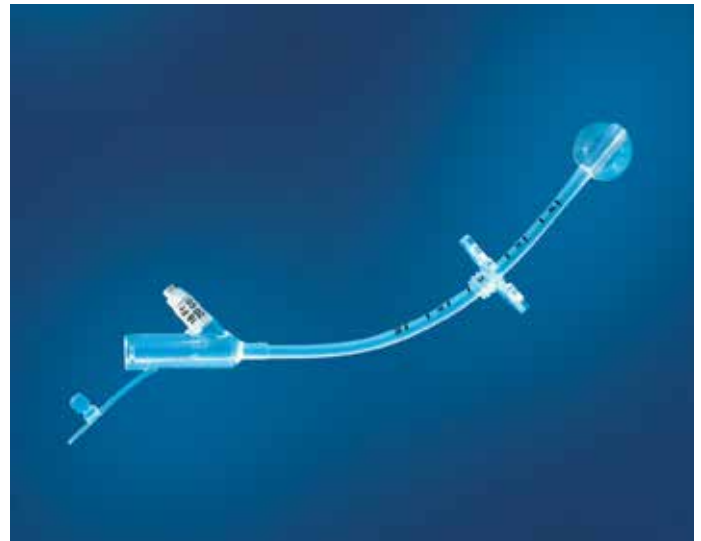
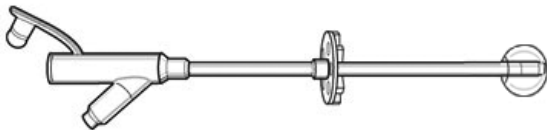

Code	Size (Outer Diameter)	Balloon Volume	Packaging
0110-12LV	12 Fr	3–5ml Balloon	1 each
0110-14LV	14 Fr	3–5ml Balloon	1 each
0110-16LV	16 Fr	3–5ml Balloon	1 each
0110-18	18 Fr	7–10ml Balloon	1 each
0110-20	20 Fr	7–10ml Balloon	1 each
0110-22	22 Fr	7–10ml Balloon	1 each
0110-24	24 Fr	7–10ml Balloon	1 each

HALYARD* GASTROSTOMY FEEDING TUBES

- Medical Grade Silicone Construction
- Low-Profile Design
- Tapered Distal Tip
- Silicone Internal Retention Balloon
- Distal Tip Recessed at 5ml
- Proximal Anti-Reflux Valve
- SECUR-LOK* Extension Set Connector Mechanism
- Radiopaque Stripe
- Wide Variety of Extension Sets Available
- Gamma Sterilised

Kit includes:

- 1- MIC-KEY* Low-Profile Feeding Tube
- 1- MIC-KEY* Extension Set with SECUR-LOK* Right Angle Connector and 2 Port "Y" and Clamp – 12", 30.5cm Length
- 1- MIC-KEY* Bolus Extension Set with Cath Tip, SECUR-LOK* Straight Connector and Clamp – 12", 30.5cm Length
- 1- 6ml Syringe
- 1- 35ml Catheter Tip Syringe
- 4- Gauze Pads



Code	Size (Outer Diameter)	Stoma Length	Balloon Volume	Packaging
0120-12-0.8	12 Fr	0.8cm	3-5ml Balloon	1 each
0120-12-1.0	12 Fr	1cm	3-5ml Balloon	1 each
0120-12-1.2	12 Fr	1.2cm	3-5ml Balloon	1 each
0120-12-1.5	12 Fr	1.5cm	3-5ml Balloon	1 each
0120-12-1.7	12 Fr	1.7cm	3-5ml Balloon	1 each
0120-12-2.0	12 Fr	2cm	3-5ml Balloon	1 each
0120-12-2.3	12 Fr	2.3cm	3-5ml Balloon	1 each
0120-12-2.5	12 Fr	2.5cm	3-5ml Balloon	1 each
0120-12-2.7	12 Fr	2.7cm	3-5ml Balloon	1 each
0120-12-3.0	12 Fr	3cm	3-5ml Balloon	1 each
0120-12-3.5	12 Fr	3.5cm	3-5ml Balloon	1 each
0120-12-4.0	12 Fr	4cm	3-5ml Balloon	1 each
0120-14-0.8	14 Fr	0.8cm	5ml Balloon	1 each
0120-14-1.0	14 Fr	1.0cm	5ml Balloon	1 each
0120-14-1.2	14 Fr	1.2cm	5ml Balloon	1 each
0120-14-1.5	14 Fr	1.5cm	5ml Balloon	1 each
0120-14-1.7	14 Fr	1.7cm	5ml Balloon	1 each
0120-14-2.0	14 Fr	2.0cm	5ml Balloon	1 each
0120-14-2.3	14 Fr	2.3cm	5ml Balloon	1 each
0120-14-2.5	14 Fr	2.5cm	5ml Balloon	1 each
0120-14-2.7	14 Fr	2.7cm	5ml Balloon	1 each
0120-14-3.0	14 Fr	3.0cm	5ml Balloon	1 each
0120-14-3.5	14 Fr	3.5cm	5ml Balloon	1 each
0120-14-4.0	14 Fr	4.0cm	5ml Balloon	1 each
0120-14-4.5	14 Fr	4.5cm	5ml Balloon	1 each
0120-14-5.0	14 Fr	5cm	5ml Balloon	1 each

Code	Size (Outer Diameter)	Stoma Length	Balloon Volume	Packaging
0120-16-0.8	16 Fr	0.8cm	5ml Balloon	1 each
0120-16-1.0	16 Fr	1.0cm	5ml Balloon	1 each
0120-16-1.2	16 Fr	1.2cm	5ml Balloon	1 each
0120-16-1.5	16 Fr	1.5cm	5ml Balloon	1 each
0120-16-1.7	16 Fr	1.7cm	5ml Balloon	1 each
0120-16-2.0	16 Fr	2.0cm	5ml Balloon	1 each
0120-16-2.3	16 Fr	2.3cm	5ml Balloon	1 each
0120-16-2.5	16 Fr	2.5cm	5ml Balloon	1 each
0120-16-2.7	16 Fr	2.7cm	5ml Balloon	1 each
0120-16-3.0	16 Fr	3.0cm	5ml Balloon	1 each
0120-16-3.5	16 Fr	3.5cm	5ml Balloon	1 each
0120-16-4.0	16 Fr	4.0cm	5ml Balloon	1 each
0120-16-4.5	16 Fr	4.5cm	5ml Balloon	1 each
0120-16-5.0	16 Fr	5cm	5ml Balloon	1 each
0120-18-0.8	18 Fr	0.8cm	5ml Balloon	1 each
0120-18-1.0	18 Fr	1.0cm	5ml Balloon	1 each
0120-18-1.2	18 Fr	1.2cm	5ml Balloon	1 each
0120-18-1.5	18 Fr	1.5cm	5ml Balloon	1 each
0120-18-1.7	18 Fr	1.7cm	5ml Balloon	1 each
0120-18-2.0	18 Fr	2.0cm	5ml Balloon	1 each
0120-18-2.3	18 Fr	2.3cm	5ml Balloon	1 each
0120-18-2.5	18 Fr	2.5cm	5ml Balloon	1 each
0120-18-2.7	18 Fr	2.7cm	5ml Balloon	1 each
0120-18-3.0	18 Fr	3.0cm	5ml Balloon	1 each
0120-18-3.5	18 Fr	3.5cm	5ml Balloon	1 each
0120-18-4.0	18 Fr	4.0cm	5ml Balloon	1 each
0120-18-4.5	18 Fr	4.5cm	5ml Balloon	1 each
0120-18-5.0	18 Fr	5.0cm	5ml Balloon	1 each

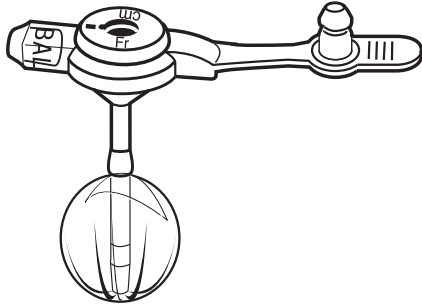

Code	Size (Outer Diameter)	Stoma Length	Balloon Volume	Packaging
0120-20-0.8	20 Fr	0.8cm	5ml Balloon	1 each
0120-20-1.0	20 Fr	1.0cm	5ml Balloon	1 each
0120-20-1.2	20 Fr	1.2cm	5ml Balloon	1 each
0120-20-1.5	20 Fr	1.5cm	5ml Balloon	1 each
0120-20-1.7	20 Fr	1.7cm	5ml Balloon	1 each
0120-20-2.0	20 Fr	2.0cm	5ml Balloon	1 each
0120-20-2.3	20 Fr	2.3cm	5ml Balloon	1 each
0120-20-2.5	20 Fr	2.5cm	5ml Balloon	1 each
0120-20-2.7	20 Fr	2.7cm	5ml Balloon	1 each
0120-20-3.0	20 Fr	3.0cm	5ml Balloon	1 each
0120-20-3.5	20 Fr	3.5cm	5ml Balloon	1 each
0120-20-4.0	20 Fr	4.0cm	5ml Balloon	1 each
0120-20-4.5	20 Fr	4.5cm	5ml Balloon	1 each
0120-20-5.0	20 Fr	5.0cm	5ml Balloon	1 each
0120-24-1.5	24 Fr	1.5cm	5ml Balloon	1 each
0120-24-1.7	24 Fr	1.7cm	5ml Balloon	1 each
0120-24-2.0	24 Fr	2.0cm	5ml Balloon	1 each
0120-24-2.3	24 Fr	2.3cm	5ml Balloon	1 each
0120-24-2.5	24 Fr	2.5cm	5ml Balloon	1 each
0120-24-2.7	24 Fr	2.7cm	5ml Balloon	1 each
0120-24-3.0	24 Fr	3.0cm	5ml Balloon	1 each
0120-24-3.5	24 Fr	3.5cm	5ml Balloon	1 each
0120-24-4.0	24 Fr	4.0cm	5ml Balloon	1 each
0120-24-4.5	24 Fr	4.5cm	5ml Balloon	1 each
0120-24-5.0	24 Fr	5.0cm	5ml Balloon	1 each

HALYARD* MIC-KEY* FEEDING TUBE ACCESSORIES

For use with MIC-KEY* Low-Profile Gastrostomy and Jejunal Feeding Tubes.

- Proximal Tip Types: 2 Port "Y", Bolus, and Threaded
- SECUR-LOK* "Key" Connection Mechanism
- Clear Tubing
- Medication Port on Non-Bolus Extension Sets
- Individually Packaged Extension Sets
- Tubing Clamp
- Extension Sets Non-Sterile
- Stoma Measuring Device Gamma Sterilised

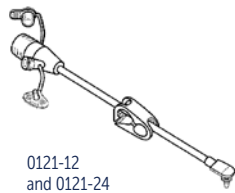

0121-12
and 0121-24

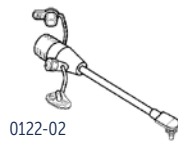

0122-02

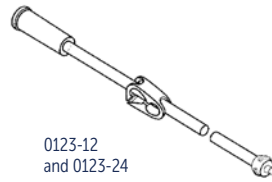

0123-12
and 0123-24

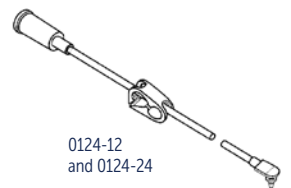

0124-12
and 0124-24

DEHP-Free Formulation Code	Length	Description	Packaging
0121-12	30.5cm	MIC-KEY* Extension Set with SECUR-LOK*, Right-Angle Connector and 2 Port "Y" and Clamp	5 each
0121-24	60.9cm	MIC-KEY* Extension Set with SECUR-LOK*, Right-Angle Connector and 2 Port "Y" and Clamp	5 each
0122-02	5.1cm	MIC-KEY* Medication Set with SECUR-LOK*, Right Angle Connector and 2 Port "Y"	5 each
0123-12	30.5cm	MIC-KEY* Bolus Extension Set with Cath Tip, SECUR-LOK* Straight Connector and Clamp	5 each
0123-24	60.9cm	MIC-KEY* Bolus Extension Set with Cath Tip, SECUR-LOK* Straight Connector and Clamp	5 each
0124-12	30.5cm	MIC-KEY* Bolus Extension Set with Cath Tip, SECUR-LOK* Right Angle Connector and Clamp	5 each
0124-24	60.9cm	MIC-KEY* Bolus Extension Set with Cath Tip, SECUR-LOK* Right Angle Connector and Clamp	5 each
0126-12	30.5cm	MIC-KEY* Threaded Extension Set with SECUR-LOK* Right Angle Connector and Clamp	5 each
0126-24	60.9cm	MIC-KEY* Threaded Extension Set with SECUR-LOK* Right Angle Connector and Clamp	5 each
98460		MIC-KEY* Stoma Measuring Device	10 each

HALYARD* MIC* FEEDING TUBE ACCESSORIES

For Use with MIC* Gastrostomy, Bolus Gastrostomy, PEG, Jejunal, Gastro-Enteric, and Transgastric-Jejunal Feeding Tubes. DEHP-Free Formulation [Di-(2-Ethylhexyl)phthalate].

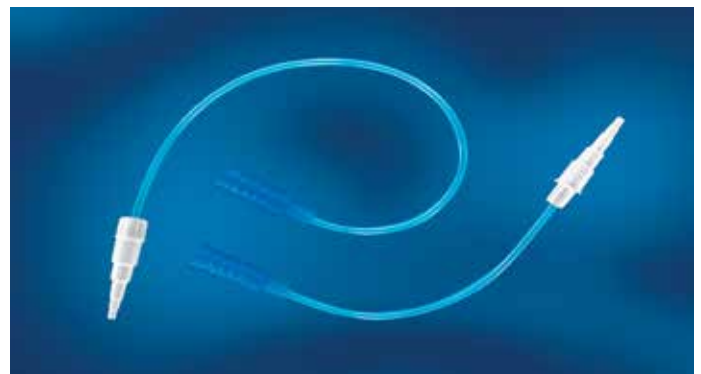

DEHP-Free Formulation Code	Length	Description	Packaging
0105-06	15cm 6"	Extension Tubing with Bolus and Stepped Connectors at Opposite Ends	5 each
0105-12	30cm 12"	Extension Tubing with Bolus and Stepped Connectors at Opposite Ends	5 each

HALYARD* MIC* TRANSGASTRIC- JEJUNAL FEEDING TUBES – ENDOSCOPIC / RADIOLOGY PLACEMENT

- Medical Grade Silicone Construction
- Silicone Internal Retention Balloon
- SECUR-LOK* External Retention Ring
- Universal Jejunal Feeding Port Connector
- Gastric Decompression Port
- Multiple Gastric & Jejunal Exit Ports
- Tungsten Weighted Jejunal Portion
- Tapered Distal Tip
- Radiopaque Stripe
- Ethylene Oxide (ETO) Sterilised

Kit includes:

- 1- Transgastric Jejunal Feeding Tube
- 1- Silicone Coated Guidewire
- 1- LUER-SLIP* Syringe
- 1- 35ml Catheter Tip Syringe
- 1- SECUR-LOK* External Retention Ring
- 1- Directions for Use
- 1- Patient Care Guidelines

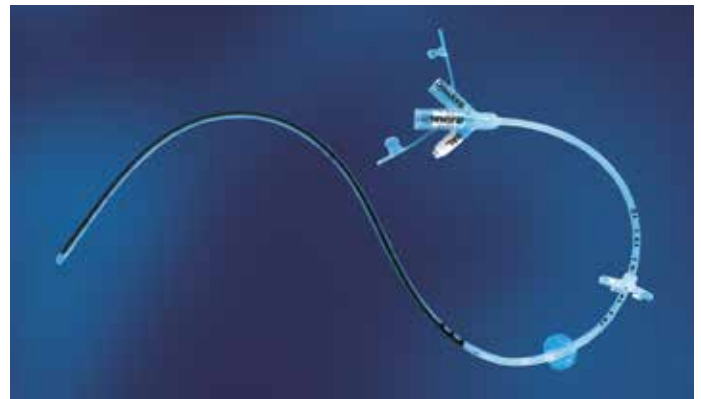
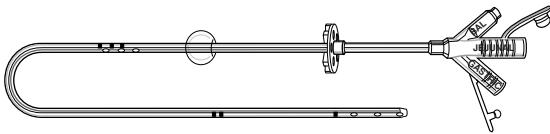

Code	Size (Outer Diameter)	Jejunal Length [†]	Balloon Volume	Packaging
0650-16-15	16 Fr	15cm	7-10ml Balloon	1 each
0650-16-22	16 Fr	22cm	7-10ml Balloon	1 each
0650-16-30	16 Fr	30cm	7-10ml Balloon	1 each
0650-16-45	16 Fr	45cm	7-10ml Balloon	1 each
0650-18-22	18 Fr	22cm	7-10ml Balloon	1 each
0650-18-30	18 Fr	30cm	7-10ml Balloon	1 each
0650-18-45	18 Fr	45cm	7-10ml Balloon	1 each
0650-22-45	22 Fr	45cm	7-10ml Balloon	1 each

[†] Jejunal length measured from the distal aspect of the retention balloon to the catheter tip.

HALYARD* MIC* TRANSGASTRIC- JEJUNAL FEEDING TUBES – SURGICAL PLACEMENT KITS

- Medical Grade Silicone Construction
- Silicone Internal Retention Balloon
- SECUR-LOK* External Retention Ring
- Universal Jejunal Feeding Port Connector
- Gastric Decompression Port
- Multiple Gastric & Jejunal Exit Ports
- Tungsten Weighted Jejunal Portion
- Tapered Distal Tip
- Radiopaque Stripe
- Ethylene Oxide (ETO) Sterilised

Kit includes:

- 1- Transgastric-Jejunal Feeding Tube
- 1- Abdominal Trocar and Sheath
- 1- Slotted Transpyloric Cannula
- 1- SECUR-LOK* External Retention Ring
- 1- Directions for Use
- 1- Patient Care Guidelines

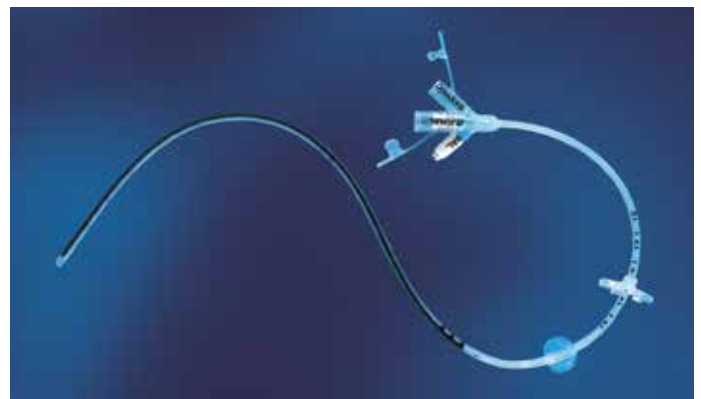
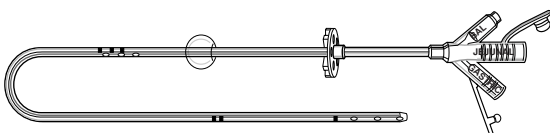

Code	Size (Outer Diameter)	Jejunal Length [†]	Balloon Volume	Packaging
0660-16	16 Fr	45cm	7-10ml Balloon	1 each
0660-18	18 Fr	45cm	7-10ml Balloon	1 each
0660-22	22 Fr	45cm	7-10ml Balloon	1 each

[†] Jejunal length measured from the distal aspect of the retention balloon to the catheter tip.

HALYARD* MIC-KEY* LOW-PROFILE TRANSGASTRIC-JEJUNAL TUBES – ENDOSCOPIC/RADIOLOGY PLACEMENT KITS

- Unobtrusive and easy to conceal
- Multiple feeding exit ports to help improve flow and minimise clogging
- Tungsten weighted jejunal portion to maintain jejunal position
- Radiopaque stripe to help aid in catheter visualisation
- Clearly marked separate gastric and jejunal ports for ease of identification
- High-clarity medical grade silicone designed for visibility and drapability
- Tapered distal tip for non-traumatic tube insertion

Kit includes:

- 1- MIC-KEY* Low-Profile Transgastric-Jejunal Feeding Tube
- 1- Introducer Cannula
- 1- MIC-KEY* Extension Set with SECUR-LOK* Right Angle Connector and 2 Port "Y" and Clamp – 12", 30.5cm Length
- 1- MIC-KEY* Bolus Extension Set with Cath Tip, SECUR-LOK* Straight Connector and Clamp – 12", 30.5cm Length
- 1- 6ml LUER-SLIP* Syringe
- 4- Gauze Pads
- 1- Directions for Use
- 1- Patient Care Guidelines

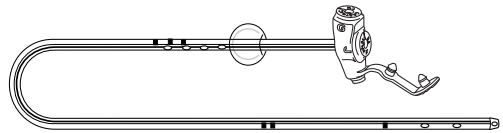

Code	Size (Outer Diameter)	Stoma Length	Jejunal Length†	Balloon Volume	Packaging
0270-16-1.0-15	16 Fr	1.0cm	15cm	3–5ml	1 each
0270-16-1.0-22	16 Fr	1.0cm	22cm	3–5ml	1 each
0270-16-1.2-15	16 Fr	1.2cm	15cm	3–5ml	1 each
0270-16-1.2-22	16 Fr	1.2cm	22cm	3–5ml	1 each
0270-16-1.2-30	16 Fr	1.2cm	30cm	3–5ml	1 each
0270-16-1.5-15	16 Fr	1.5cm	15cm	3–5ml	1 each
0270-16-1.5-22	16 Fr	1.5cm	22cm	3–5ml	1 each
0270-16-1.5-30	16 Fr	1.5cm	30cm	3–5ml	1 each
0270-16-1.5-45	16 Fr	1.5cm	45cm	7–10ml	1 each
0270-16-1.7-15	16 Fr	1.7cm	15cm	3–5ml	1 each
0270-16-1.7-22	16 Fr	1.7cm	22cm	3–5ml	1 each
0270-16-1.7-30	16 Fr	1.7cm	30cm	3–5ml	1 each
0270-16-1.7-45	16 Fr	1.7cm	45cm	7–10ml	1 each
0270-16-2.0-22	16 Fr	2.0cm	22cm	3–5ml	1 each
0270-16-2.0-30	16 Fr	2.0cm	30cm	3–5ml	1 each
0270-16-2.0-45	16 Fr	2.0cm	45cm	7–10ml	1 each
0270-16-2.3-30	16 Fr	2.3cm	30cm	3–5ml	1 each
0270-16-2.3-45	16 Fr	2.3cm	45cm	7–10ml	1 each
0270-16-2.5-30	16 Fr	2.5cm	30cm	3–5ml	1 each
0270-16-2.5-45	16 Fr	2.5cm	45cm	7–10ml	1 each
0270-16-2.7-30	16 Fr	2.7cm	30cm	3–5ml	1 each
0270-16-2.7-45	16 Fr	2.7cm	45cm	7–10ml	1 each
0270-16-3.0-45	16 Fr	3.0cm	45cm	7–10ml	1 each
0270-16-3.5-45	16 Fr	3.5cm	45cm	7–10ml	1 each

† Jejunal length measured from the distal aspect of the retention balloon to the catheter tip.

Code	Size (Outer Diameter)	Stoma Length	Jejunal Length†	Balloon Volume	Packaging
0270-18-1.2-22	18 Fr	1.2cm	22cm	3–5ml	1 each
0270-18-1.2-30	18 Fr	1.2cm	30cm	3–5ml	1 each
0270-18-1.5-22	18 Fr	1.5cm	22cm	3–5ml	1 each
0270-18-1.5-30	18 Fr	1.5cm	30cm	3–5ml	1 each
0270-18-1.5-45	18 Fr	1.5cm	45cm	7–10ml	1 each
0270-18-1.7-22	18 Fr	1.7cm	22cm	3–5ml	1 each
0270-18-1.7-30	18 Fr	1.7cm	30cm	3–5ml	1 each
0270-18-1.7-45	18 Fr	1.7cm	45cm	7–10ml	1 each
0270-18-2.0-22	18 Fr	2.0cm	22cm	3–5ml	1 each
0270-18-2.0-30	18 Fr	2.0cm	30cm	3–5ml	1 each
0270-18-2.0-45	18 Fr	2.0cm	45cm	7–10ml	1 each
0270-18-2.3-30	18 Fr	2.3cm	30cm	3–5ml	1 each
0270-18-2.3-45	18 Fr	2.3cm	45cm	7–10ml	1 each
0270-18-2.5-30	18 Fr	2.5cm	30cm	3–5ml	1 each
0270-18-2.5-45	18 Fr	2.5cm	45cm	7–10ml	1 each
0270-18-2.7-30	18 Fr	2.7cm	30cm	3–5ml	1 each
0270-18-2.7-45	18 Fr	2.7cm	45cm	7–10ml	1 each
0270-18-3.0-45	18 Fr	3.0cm	45cm	7–10ml	1 each
0270-18-3.5-45	18 Fr	3.5cm	45cm	7–10ml	1 each
0270-22-1.5-45	22 Fr	1.5cm	45cm	7–10ml	1 each
0270-22-1.7-45	22 Fr	1.7cm	45cm	7–10ml	1 each
0270-22-2.0-45	22 Fr	2.0cm	45cm	7–10ml	1 each
0270-22-2.3-45	22 Fr	2.3cm	45cm	7–10ml	1 each
0270-22-2.5-45	22 Fr	2.5cm	45cm	7–10ml	1 each
0270-22-2.7-45	22 Fr	2.7cm	45cm	7–10ml	1 each
0270-22-3.0-45	22 Fr	3.0cm	45cm	7–10ml	1 each
0270-22-3.5-45	22 Fr	3.5cm	45cm	7–10ml	1 each

† Jejunal length measured from the distal aspect of the retention balloon to the catheter tip.

NOTE: Please see package inserts for directions for use for each of these products.

HALYARD* MIC* JEJUNAL FEEDING TUBES

Code	Size (Outer Diameter)	Balloon Volume	Packaging
0200-12LV	12 Fr	2-3ml Balloon	2 eaches
0200-14	14 Fr	7-10ml Balloon	2 eaches
0200-16	16 Fr	7-10ml Balloon	2 eaches
0200-18	18 Fr	7-10ml Balloon	2 eaches
0200-20	20 Fr	7-10ml Balloon	2 eaches
0200-22	22 Fr	7-10ml Balloon	2 eaches
0200-24	24 Fr	7-10ml Balloon	2 eaches



HALYARD* MIC-KEY* LOW-PROFILE JEJUNAL FEEDING TUBES

Code	Size (Outer Diameter)	Stoma Length	Balloon Volume	Packaging
0230-14-0.8	14 Fr	0.8cm	5ml Balloon	1 each
0230-14-1.0	14 Fr	1.0cm	5ml Balloon	1 each
0230-14-1.2	14 Fr	1.2cm	5ml Balloon	1 each
0230-14-1.5	14 Fr	1.5cm	5ml Balloon	1 each
0230-14-1.7	14 Fr	1.7cm	5ml Balloon	1 each
0230-14-2.0	14 Fr	2.0cm	5ml Balloon	1 each
0230-14-2.3	14 Fr	2.3cm	5ml Balloon	1 each
0230-14-2.5	14 Fr	2.5cm	5ml Balloon	1 each
0230-14-2.7	14 Fr	2.7cm	5ml Balloon	1 each
0230-14-3.0	14 Fr	3.0cm	5ml Balloon	1 each
0230-14-3.5	14 Fr	3.5cm	5ml Balloon	1 each
0230-14-4.0	14 Fr	4.0cm	5ml Balloon	1 each
0230-14-4.5	14 Fr	4.5cm	5ml Balloon	1 each
0230-18-0.8	18 Fr	0.8cm	5ml Balloon	1 each
0230-18-1.0	18 Fr	1.0cm	5ml Balloon	1 each
0230-18-1.2	18 Fr	1.2cm	5ml Balloon	1 each
0230-18-1.5	18 Fr	1.5cm	5ml Balloon	1 each
0230-18-1.7	18 Fr	1.7cm	5ml Balloon	1 each
0230-18-2.0	18 Fr	2.0cm	5ml Balloon	1 each
0230-18-2.3	18 Fr	2.3cm	5ml Balloon	1 each
0230-18-2.5	18 Fr	2.5cm	5ml Balloon	1 each
0230-18-2.7	18 Fr	2.7cm	5ml Balloon	1 each
0230-18-3.0	18 Fr	3.0cm	5ml Balloon	1 each
0230-18-3.5	18 Fr	3.5cm	5ml Balloon	1 each
0230-18-4.0	18 Fr	4.0cm	5ml Balloon	1 each
0230-18-4.5	18 Fr	4.5cm	5ml Balloon	1 each

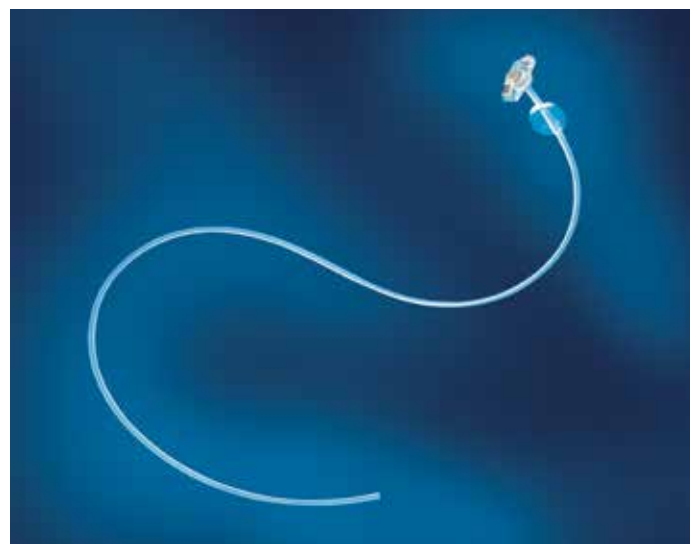

NOTE: Please see package inserts for directions for use for each of these products.

HALYARD* MIC* JEJUNOSTOMY FEEDING TUBE

- Medical Grade Silicone Construction
- Suture Wings
- 9 Fr Internal Diameter
- Radiopaque Stripe
- Gamma Sterilised

Kit includes:

- 1- Jejunostomy Tube
- 1- Subcutaneous Extraducer
- 1- Feeding Port Adapter
- 1- LUER-LOK* Cap

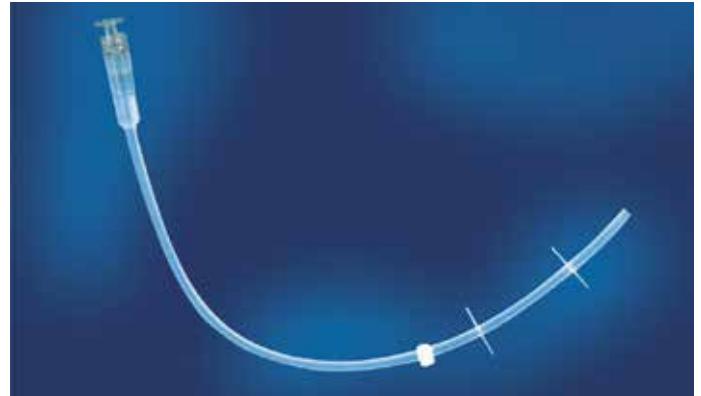
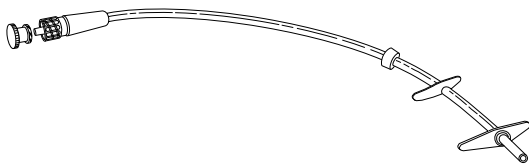

Code	Size (Outer Diameter)	Description	Packaging
0301-14	14 Fr / 9 Fr	Jejunostomy Feeding Tube	2 eaches

HALYARD* MIC* JEJUNOSTOMY FEEDING TUBE ACCESSORIES

For use with the MIC* Jejunostomy Feeding Tube.



Code	Description	Packaging
0301-50	Jejunostomy Repair Kit – Includes Silicone Med A Medical Adhesive, Stent, Syringe, Blunt Tip Needle, Suture, Silicone Overcollar	1 each
0301-55	Jejunostomy LUER-LOK* Caps	5 each
0301-60	Jejunostomy Feeding Port Adapter	5 each

HALYARD* FOREIGN BODY HOOD PROTECTOR

- Non-Sterile
- Disposable

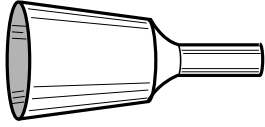

Code	Description	Packaging
69392 [†]	Bell-Shaped, Foreign Body Hood Protector	10 each

[†] Caution: this product contains natural rubber latex which may cause allergic reactions.



Infection Prevention Product Solutions
Halyard* Education Foundation
Tools & Best Practice
Commitment to Excellence and Sustainability
Experienced Customer Support
Knowledgeable Sales Force
Innovation & Technology



Halyard Australia Pty. Limited
Phone: 1800 101 021

Halyard New Zealand
Phone: 0800 482 211

www.halyardhealth.com.au

www.halyardhealth.com.au



Halyard Health makes no representation that its products described in this catalogue will provide complete protection from exposure to contaminants, fluids or micro-organisms or will eliminate the risk of contracting infectious diseases.

*Registered Trademark or Trademark of Halyard Health, Inc. or its affiliates. © 2015 HYH. All rights reserved.
DH:EF:1506:WFHY628